

Data Sheet



Article number: 604132048030

Description: Taper bored timing belt pulley
HTD 48 8M 30 TL 2012

Measures

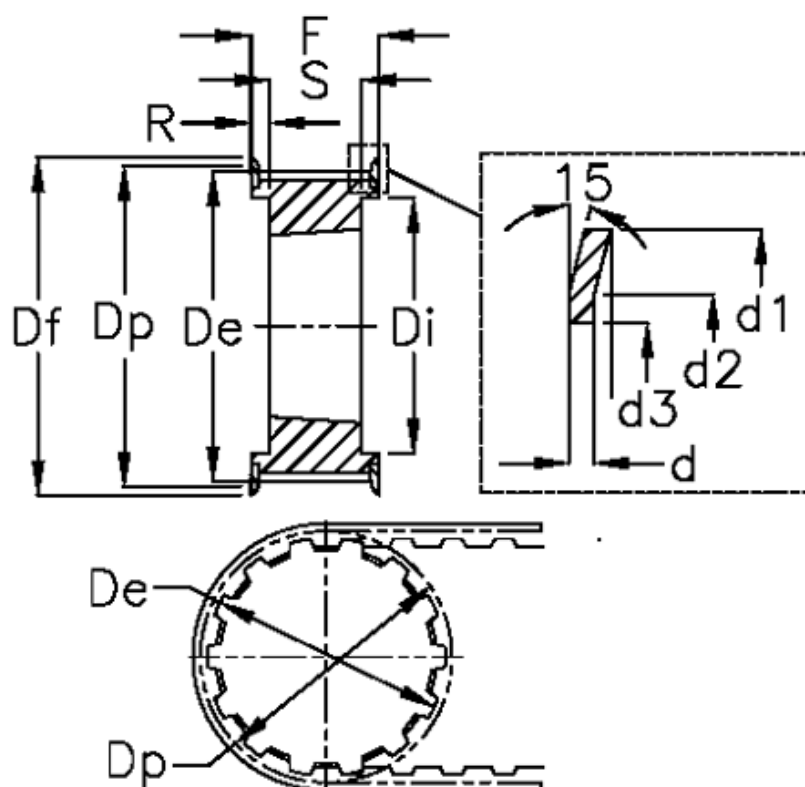

d = 1.5	F = 38	Weight = 1.78
d1 = 128	Flange type = F40	Width = 30
d2 = 124	For bushing = 2012	
d3 = 107	Max bore = 50	
De = 120.86	r = 6	
Df = 128	S = 32	
Di = 90	Tooth number = 48	
Dp = 122.23	Type = 8M	